



Øyvind Moe og Jonas Rushfeldt Sjøtun
Bachelorprosjekt I8E

TAKK TIL

- Referansegruppa 47E
Andreas Langli og Steffen Lilleevjen
- Veileder
Jostein Lund
- Teknisk konsultasjon
Tor-Ivar Melling, André Gaustad og Hans-Christian Erikstad

AGENDA

- Om oppgaven
- Dagens systemer
- Planlegging av prosjektet
- Vår løsning
- Prosessen
- Videre arbeid

OM OPPGAVEN

- Oppgavestiller
IIE, NTNU
- Problemstilling
Utføre en implementasjon som tar i bruk Microsoft System Center 2016 og Microsoft Intunes løsninger for programvaredistribusjon, klientsikkerhet og overvåkning, samt automatiseringsfunksjoner gjort mulig med Microsoft Powershell.

DAGENS SYSTEMER

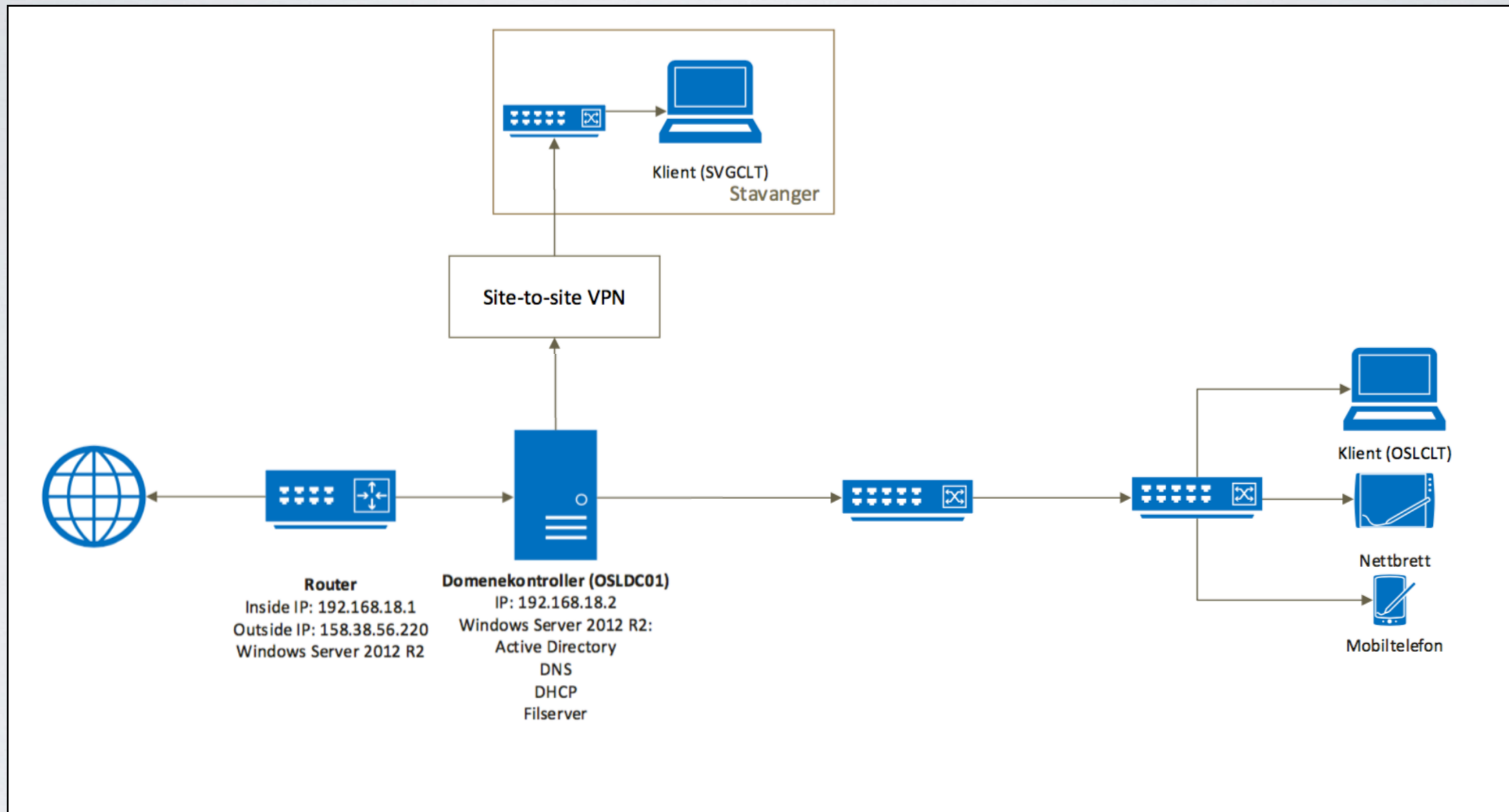

RUTER OG DOMENEKONTROLLER

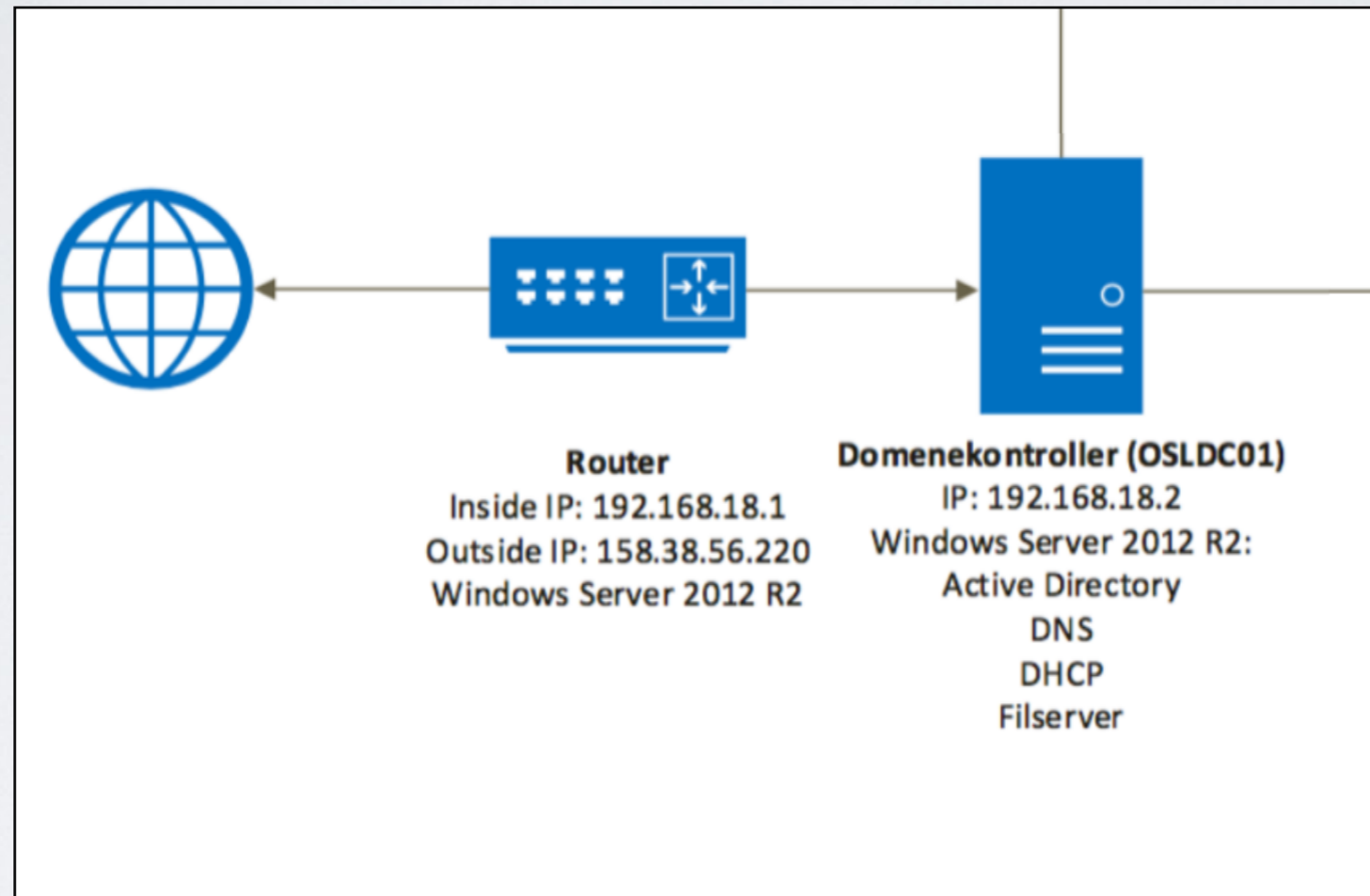

DAGENS SYSTEMER

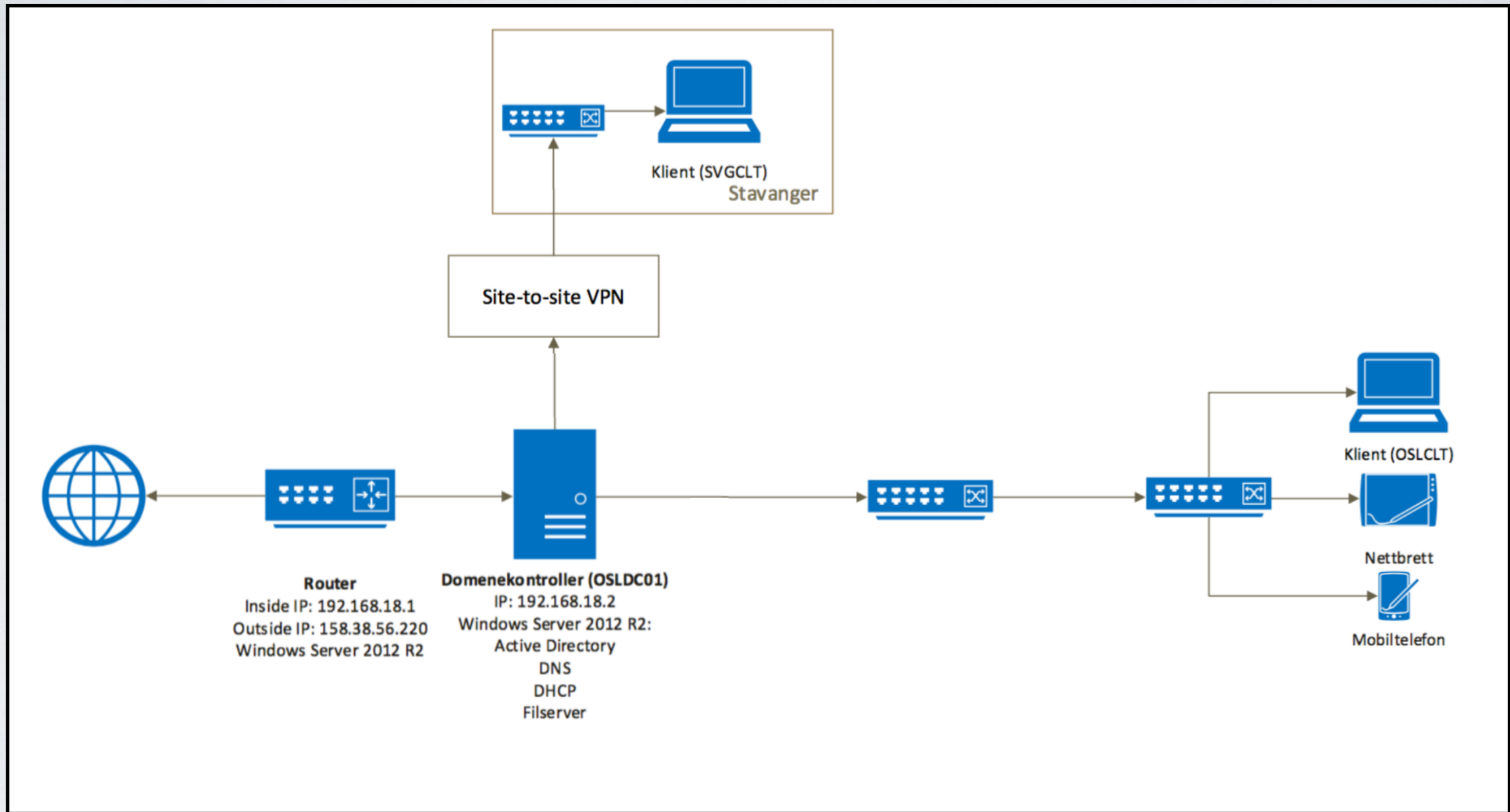

DAGENS SYSTEMER

OSLO INTRANETT

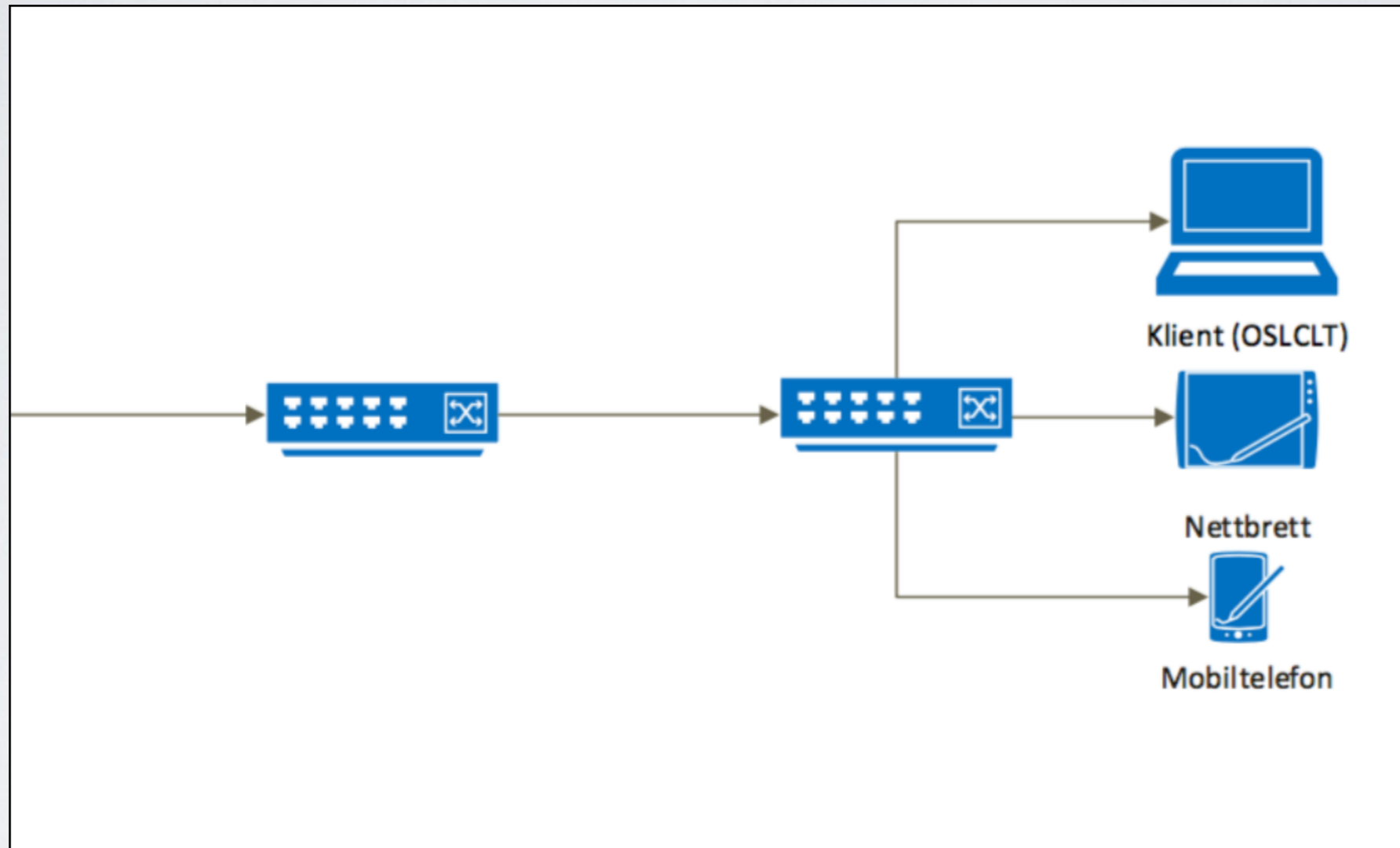

Mer informasjon tilgjengelig i
Forstudierapport

DAGENS SYSTEMER

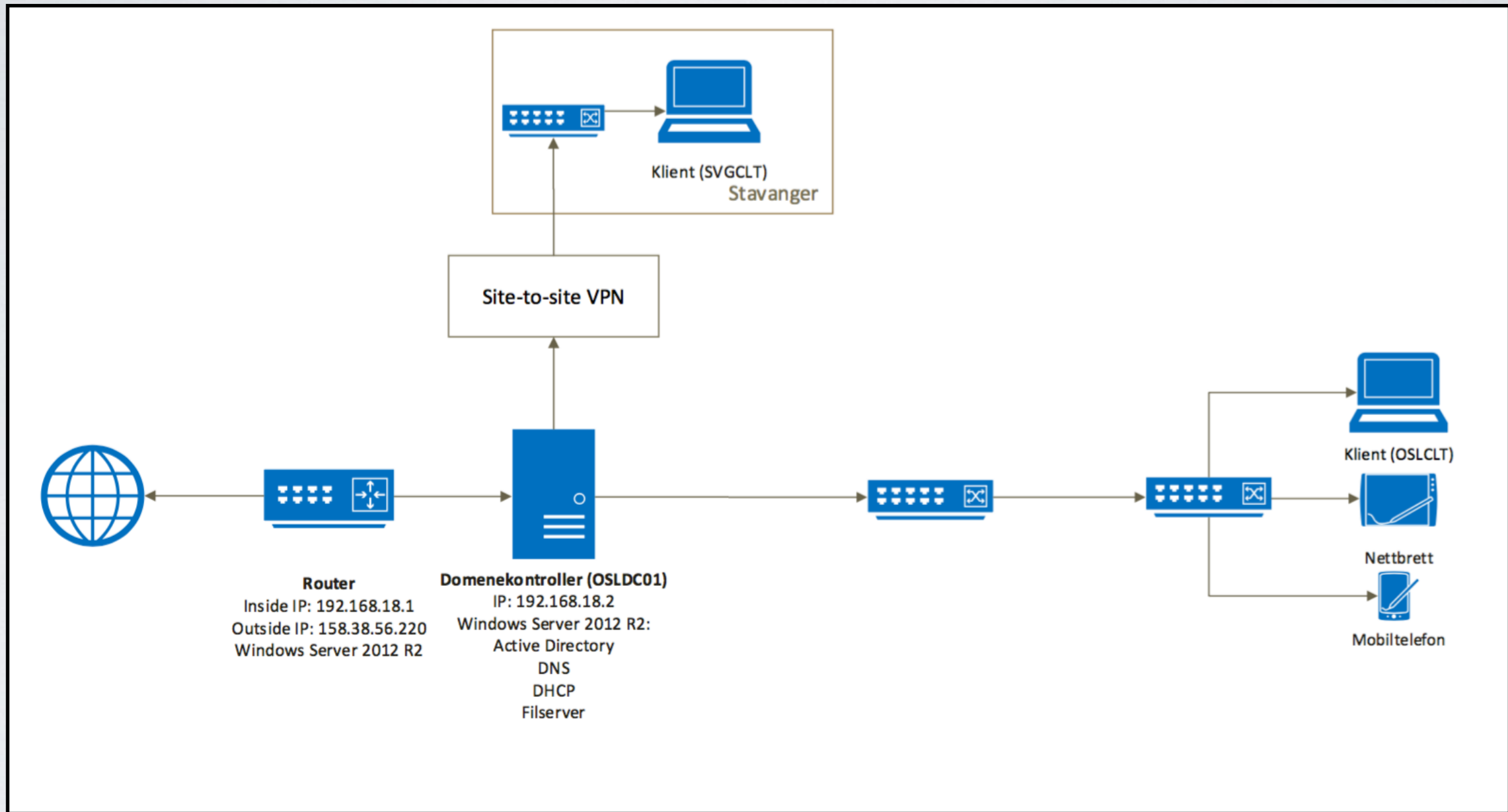

DAGENS SYSTEMER

STAVANGER INTRANETT

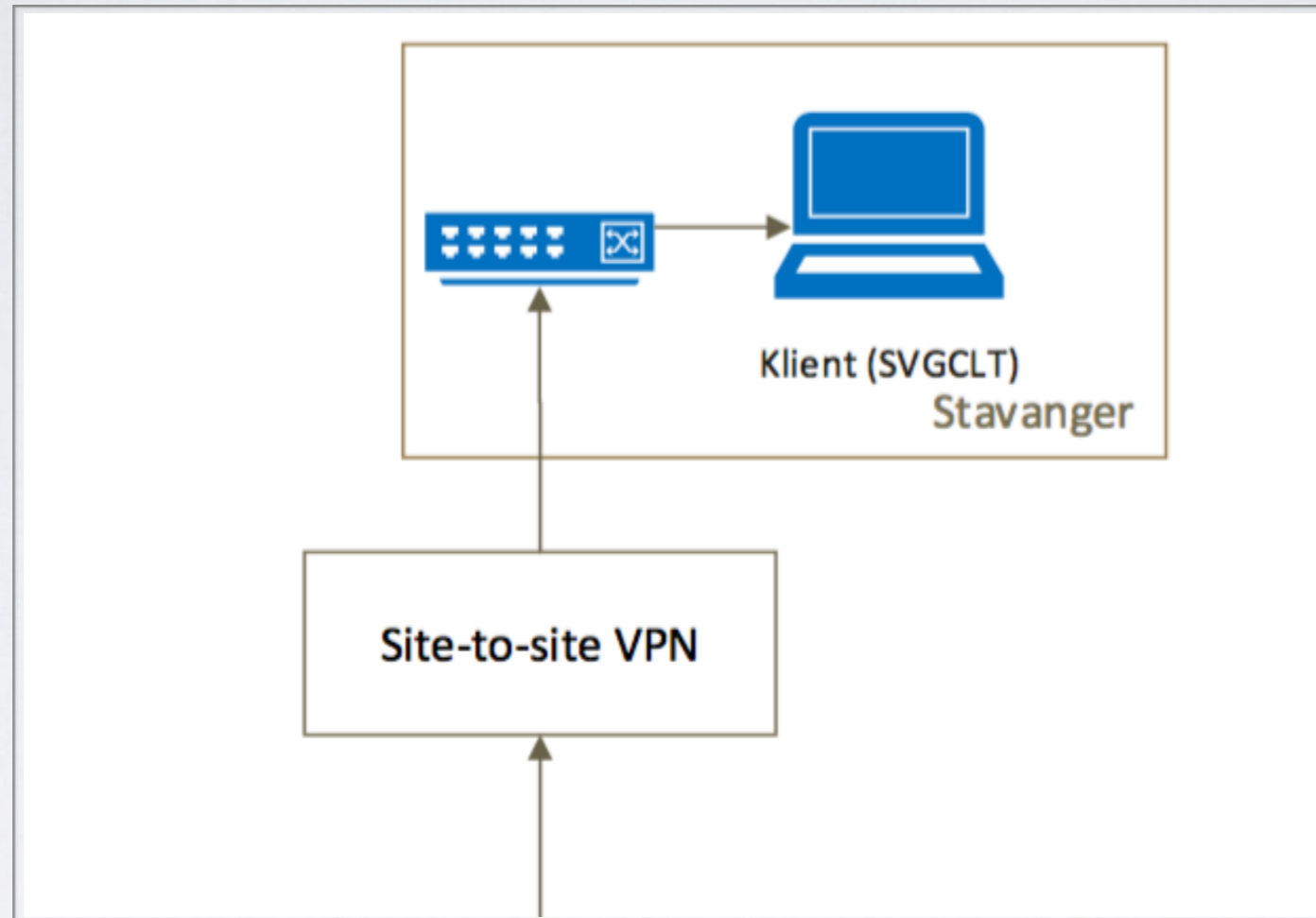

DAGENS SYSTEMER

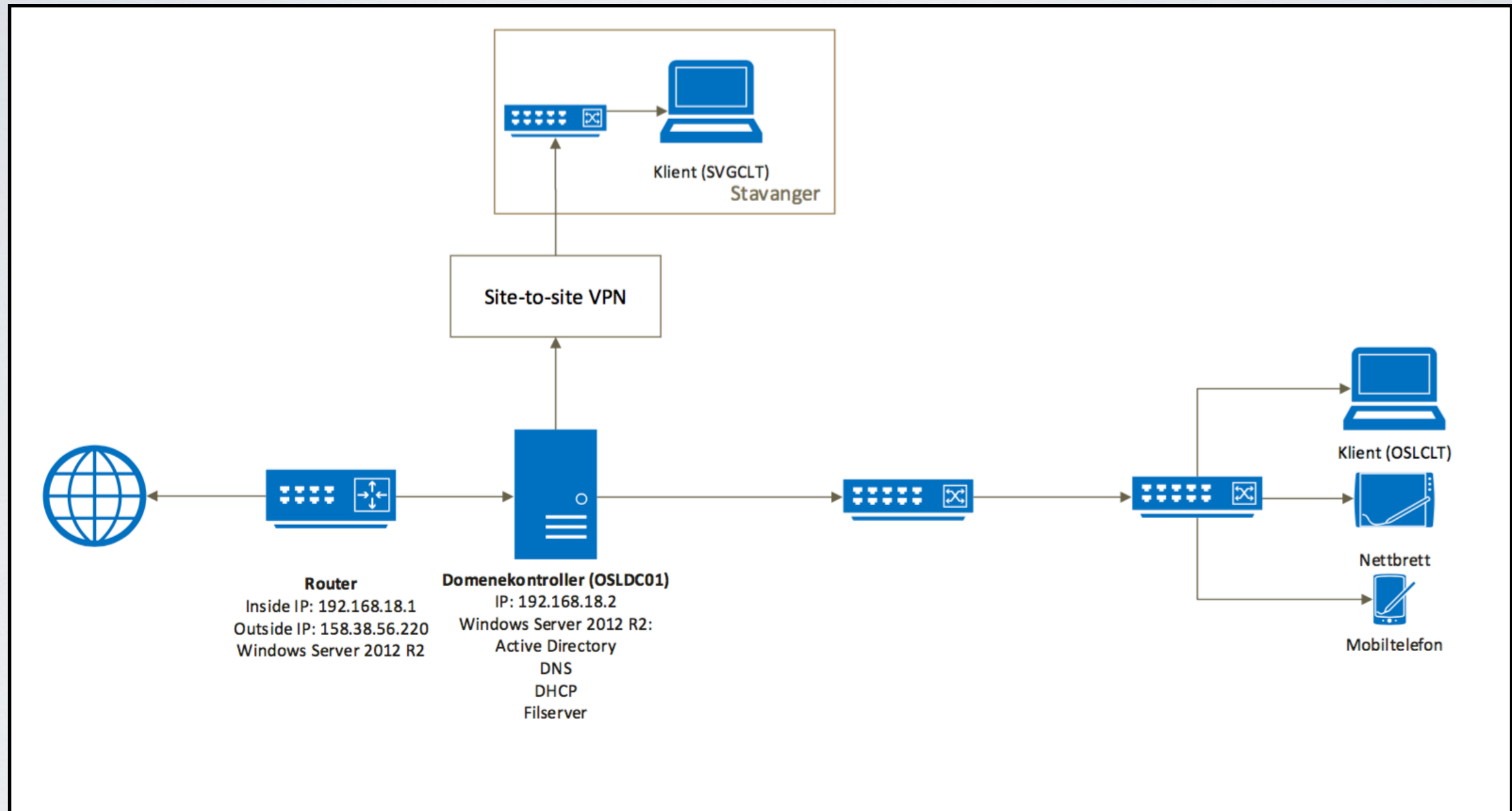

PROBLEMER MED DAGENS SYSTEM

- Fjern-administrasjon
- Programvaredistribusjon
- Sikring av mobile-enheter
- «Tanking» av klienter
- Kommunikasjon mellom Oslo og Stavanger

MÅL OG RAMMER

- Effektmål
 - Redusere kostnader og tidsbruk hos IT-avdelingen
 - Skape samkjøring og sentralisering av alle aspekter av maskinparken
- Prosessmål
 - Øke erfaring med implementasjonsprosessen
 - Øke kunnskapen om brukt programvare

MÅL OG RAMMER

- Resultatmål
 - Fullendt implementering av Microsoft SCCM 2016 og Microsoft Intune
 - Overholde tids- og kostnadsrammer

RISIKOANALYSE

- Sykdom og fravær
- **Systemkrasj**
- Leveranseproblemer
- Ny programvare feil/mangler
- **Økonomi**
- Mangel på kompetanse

KOST/NYTTTE

	År 0	År 1	År 2	År 3	År 4	Sum
Kvantifiserbar-nytte		kr 2 476 250	kr 2 476 250	kr 2 476 250	kr 2 476 250	kr 9 905 000
Bortfall kostnader		kr 3 724 000	kr 3 724 000	kr 3 724 000	kr 3 724 000	kr 14 896 000
Sum nytte		kr 6 200 250	kr 6 200 250	kr 6 200 250	kr 6 200 250	kr 24 801 000
Utviklingskostnader	kr 2 038 500					kr 2 038 500
Drift- og forvaltningskostnader		kr 2 771 100	kr 2 771 100	kr 2 771 100	kr 2 771 100	kr 11 084 400
Sum kostnader	kr 2 038 500	kr 2 771 100	kr 2 771 100	kr 2 771 100	kr 2 771 100	kr 13 122 900
Beregnet nytte (nytte-kostnader)	-kr 2 038 500	kr 3 429 150	kr 3 429 150	kr 3 429 150	kr 3 429 150	kr 11 678 100

KOST/NYTTTE

	År 0	År 1	År 2	År 3	År 4	Sum
Kvantifiserbar-nytte		kr 2 476 250	kr 2 476 250	kr 2 476 250	kr 2 476 250	kr 9 905 000
Bortfall kostnader		kr 3 724 000	kr 3 724 000	kr 3 724 000	kr 3 724 000	kr 14 896 000
Utviklingskostnader		kr 2 038 500	kr 6 200 250	kr 6 200 250	kr 6 200 250	kr 24 801 000
						kr 2 038 500
Drift- og forvaltningskostnader		kr 2 771 100	kr 2 771 100	kr 2 771 100	kr 2 771 100	kr 11 084 400
Sum kostnader	kr 2 038 500	kr 2 771 100	kr 2 771 100	kr 2 771 100	kr 2 771 100	kr 13 122 900
Beregnet nytte (nytte-kostnader)	-kr 2 038 500	kr 3 429 150	kr 3 429 150	kr 3 429 150	kr 3 429 150	kr 11 678 100

KOST/NYTTTE

	År 0	År 1	År 2	År 3	År 4	Sum
Kvantifiserbar-nytte		kr 2 476 250	kr 2 476 250	kr 2 476 250	kr 2 476 250	kr 9 905 000
Bortfall kostnader		kr 3 724 000	kr 3 724 000	kr 3 724 000	kr 3 724 000	kr 14 896 000
Sum nytte		kr 6 200 250	kr 6 200 250	kr 6 200 250	kr 6 200 250	kr 24 801 000
Utviklingskostnader	kr 2 038 500					kr 2 038 500
Drift- og forvaltningskostnader		kr 2 771 100	kr 2 771 100	kr 2 771 100	kr 2 771 100	kr 11 084 400
Sum kostnader	kr 2 038 500	kr 2 771 100	kr 2 771 100	kr 2 771 100	kr 2 771 100	kr 13 122 900
Beregnet nytte (nytte-kostnader)	-kr 2 038 500	kr 3 429 150	kr 3 429 150	kr 3 429 150	kr 3 429 150	kr 11 678 100

KOST/NYTTTE

	År 0	År 1	År 2	År 3	År 4	Sum
Kvantifiserbar-nytte		kr 2 476 250	kr 2 476 250	kr 2 476 250	kr 2 476 250	kr 9 905 000
Bortfall kostnader		kr 3 724 000	kr 3 724 000	kr 3 724 000	kr 3 724 000	kr 14 896 000
Sum nytte		kr 6 200 250	kr 6 200 250	kr 6 200 250	kr 6 200 250	kr 24 801 000
Utviklingskostnader	kr 2 038 500					
Drift- og forvaltningskostnader		kr 2 771 100	kr 2 771 100			
Sum kostnader	kr 2 038 500	kr 2 771 100	kr 2 771 100	kr 2 771 100	kr 2 771 100	kr 13 122 900
Beregnet nytte (nytte-kostnader)	-kr 2 038 500	kr 3 429 150	kr 3 429 150	kr 3 429 150	kr 3 429 150	kr 11 678 100

kr 2 771 100 kr 11 084 400

KOST/NYTTTE

	År 0	År 1	År 2	År 3	År 4	Sum
Kvantifiserbar-nytte		kr 2 476 250	kr 2 476 250	kr 2 476 250	kr 2 476 250	kr 9 905 000
Bortfall kostnader		kr 3 724 000	kr 3 724 000	kr 3 724 000	kr 3 724 000	kr 14 896 000
Sum nytte		kr 6 200 250	kr 6 200 250	kr 6 200 250	kr 6 200 250	kr 24 801 000
Utviklingskostnader	kr 2 038 500					kr 2 038 500
Drift- og forvaltningskostnader		kr 2 771 100	kr 2 771 100	kr 2 771 100	kr 2 771 100	kr 11 084 400
Sum kostnader	kr 2 038 500	kr 2 771 100	kr 2 771 100	kr 2 771 100	kr 2 771 100	kr 13 122 900
Beregnet nytte (nytte-kostnader)	-kr 2 038 500	kr 3 429 150	kr 3 429 150	kr 3 429 150	kr 3 429 150	kr 11 678 100

KOST/NYTTTE

	År 0	År 1	År 2	År 3	År 4	Sum
Kvantifiserbar-nytte		kr 2 476 250	kr 2 476 250	kr 2 476 250	kr 2 476 250	kr 9 905 000
		År 4			Sum	
Bortfall kostnader					kr 3 724 000	kr 14 896 000
Sum nytte					kr 6 200 250	kr 24 801 000
Utviklingskostnader	kr 2 038 500					kr 2 038 500
Drift- og forvaltningskostnader					kr 2 771 100	kr 11 084 400
Sum kostnader	kr 2 038 500	kr 2 771 100	kr 2 771 100	kr 2 771 100	kr 2 771 100	kr 13 122 900
Beregnet nytte (nytte-kostnader)	-kr 2 038 500	kr 3 429 150	kr 3 429 150	kr 3 429 150	kr 3 429 150	kr 11 678 100

KOST/NYTTTE

	År 0	År 1	År 2	År 3	År 4	Sum
Kvantifiserbar-nytte		kr 2 476 250	kr 2 476 250	kr 2 476 250	kr 2 476 250	kr 9 905 000
Bortfall kostnader		kr 3 724 000	kr 3 724 000	kr 3 724 000	kr 3 724 000	kr 14 896 000
Sum nytte		kr 6 200 250	kr 6 200 250	kr 6 200 250	kr 6 200 250	kr 24 801 000
Utviklingskostnader	kr 2 038 500					kr 2 038 500
Drift- og forvaltningskostnader		kr 2 771 100	kr 2 771 100	kr 2 771 100	kr 2 771 100	kr 11 084 400
Sum kostnader	kr 2 038 500	kr 2 771 100	kr 2 771 100	kr 2 771 100	kr 2 771 100	kr 13 122 900
Beregnet nytte (nytte-kostnader)	-kr 2 038 500	kr 3 429 150	kr 3 429 150	kr 3 429 150	kr 3 429 150	kr 11 678 100

KOST/NYTTTE

	År 0	År 1	År 2	År 3	År 4	Sum
Kvantifiserbar-nytte		kr 2 476 250	kr 2 476 250	kr 2 476 250	kr 2 476 250	kr 9 905 000
Bortfall kostnader		kr 3 724 000	kr 3 724 000	kr 3 724 000	kr 3 724 000	kr 14 896 000
Sum nytte		kr 6 200 250	kr 6 200 250	kr 6 200 250	kr 6 200 250	kr 24 801 000
Utviklingskostnader	kr 2 038 500					kr 2 038 500
Drift- og forvaltningskostnader		Beregnet nytte (nytte-kostnader)		kr 11 678 100		kr 2 771 100
Sum kostnader	kr 2 038 500				kr 2 771 100	kr 13 122 900
Beregnet nytte (nytte-kostnader)	-kr 2 038 500	kr 3 429 150	kr 3 429 150	kr 3 429 150	kr 3 429 150	kr 11 678 100

KOST/NYTTE

	År 0	År 1	År 2	År 3	År 4	Sum
Kvantifiserbar-nytte		kr 2 476 250	kr 2 476 250	kr 2 476 250	kr 2 476 250	kr 9 905 000
Bortfall kostnader		kr 3 724 000	kr 3 724 000	kr 3 724 000	kr 3 724 000	kr 14 896 000
Sum nytte		kr 6 200 250	kr 6 200 250	kr 6 200 250	kr 6 200 250	kr 24 801 000
Utviklingskostnader	kr 2 038 500					kr 2 038 500
Drift- og forvaltningskostnader		kr 2 771 100	kr 2 771 100	kr 2 771 100	kr 2 771 100	kr 11 084 400
Sum kostnader	kr 2 038 500	kr 2 771 100	kr 2 771 100	kr 2 771 100	kr 2 771 100	kr 13 122 900
Beregnet nytte (nytte-kostnader)	-kr 2 038 500	kr 3 429 150	kr 3 429 150	kr 3 429 150	kr 3 429 150	kr 11 678 100

VÅR LØSNING

DETALJERTE KRAV

- Fjernadministrasjon
- Sentraldistribusjon
- Sentralstyring
- Sikring av mobile enheter
- Sky-basert tilgang

VÅR LØSNING

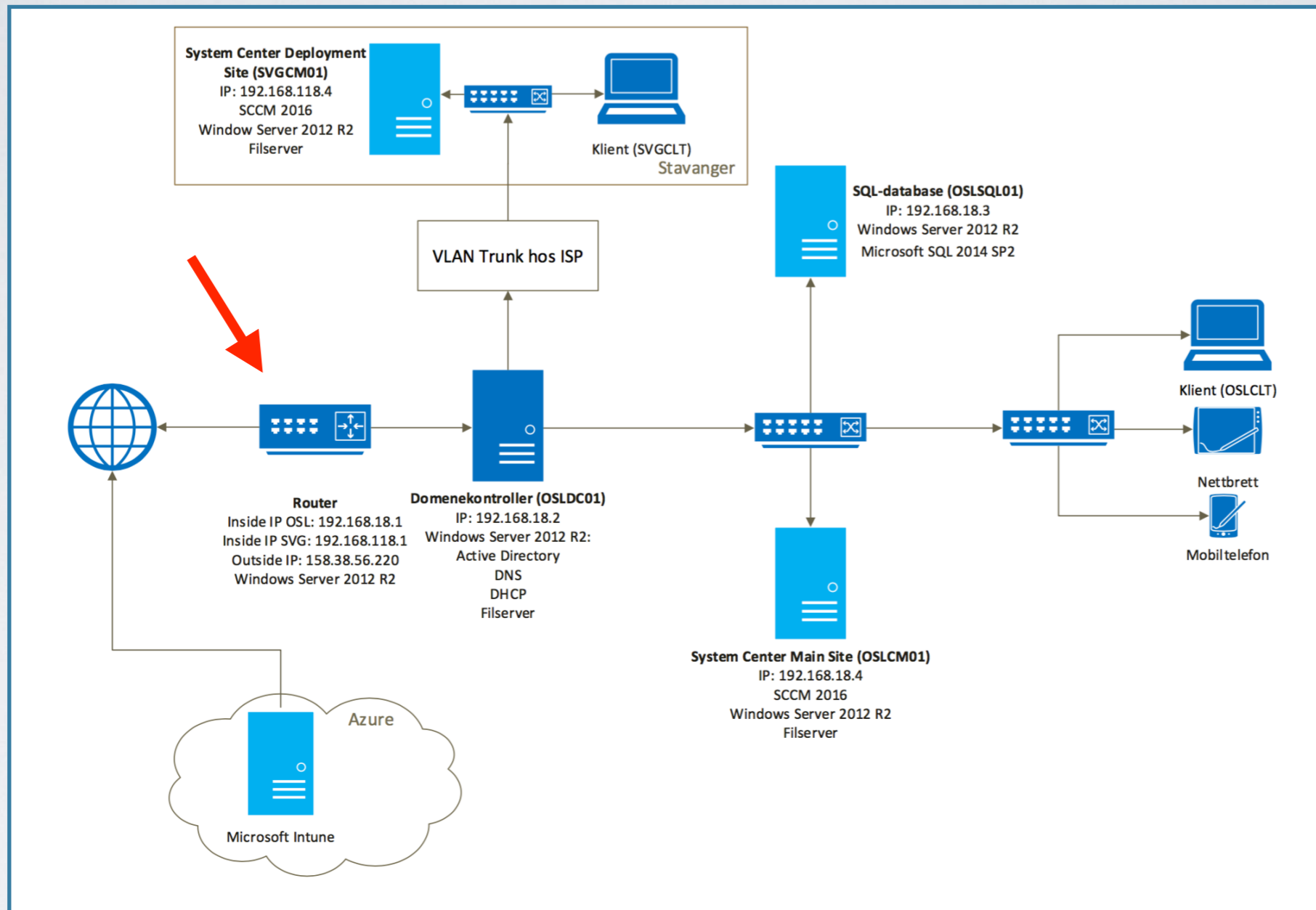

NYTT I SCCM 2016

MICROSOFT SCCM 2016

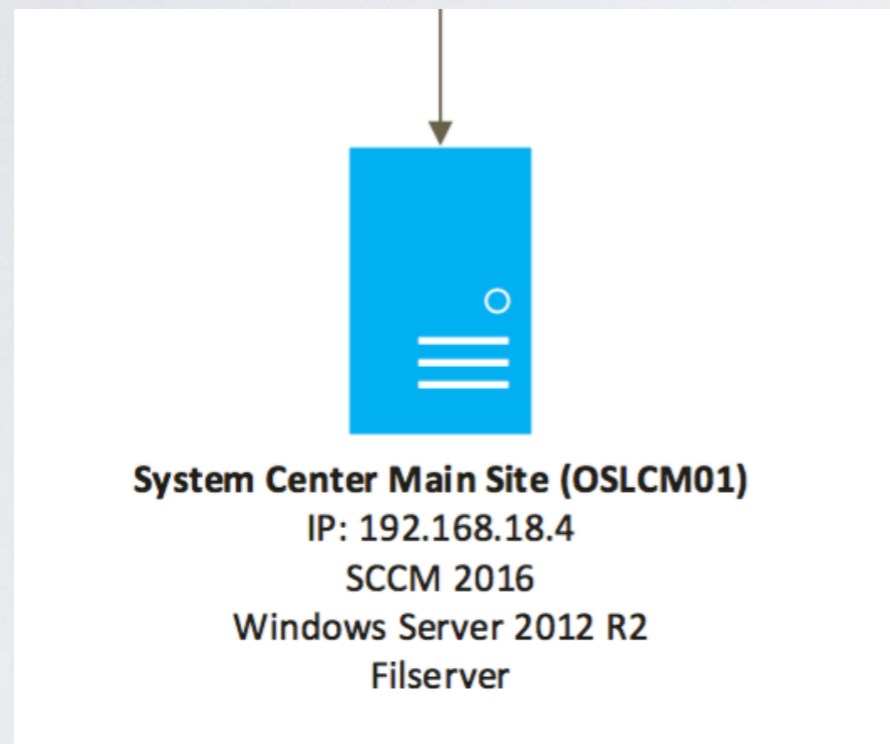

- System Center Configuration Manager 2012 R2 SP2
- Nytt software center
- Tett integrasjon mot Windows 10
- Hybrid-connector
- Preferred-management points

NYTT | SCCM 2016

NYTT SOFTWARE CENTER

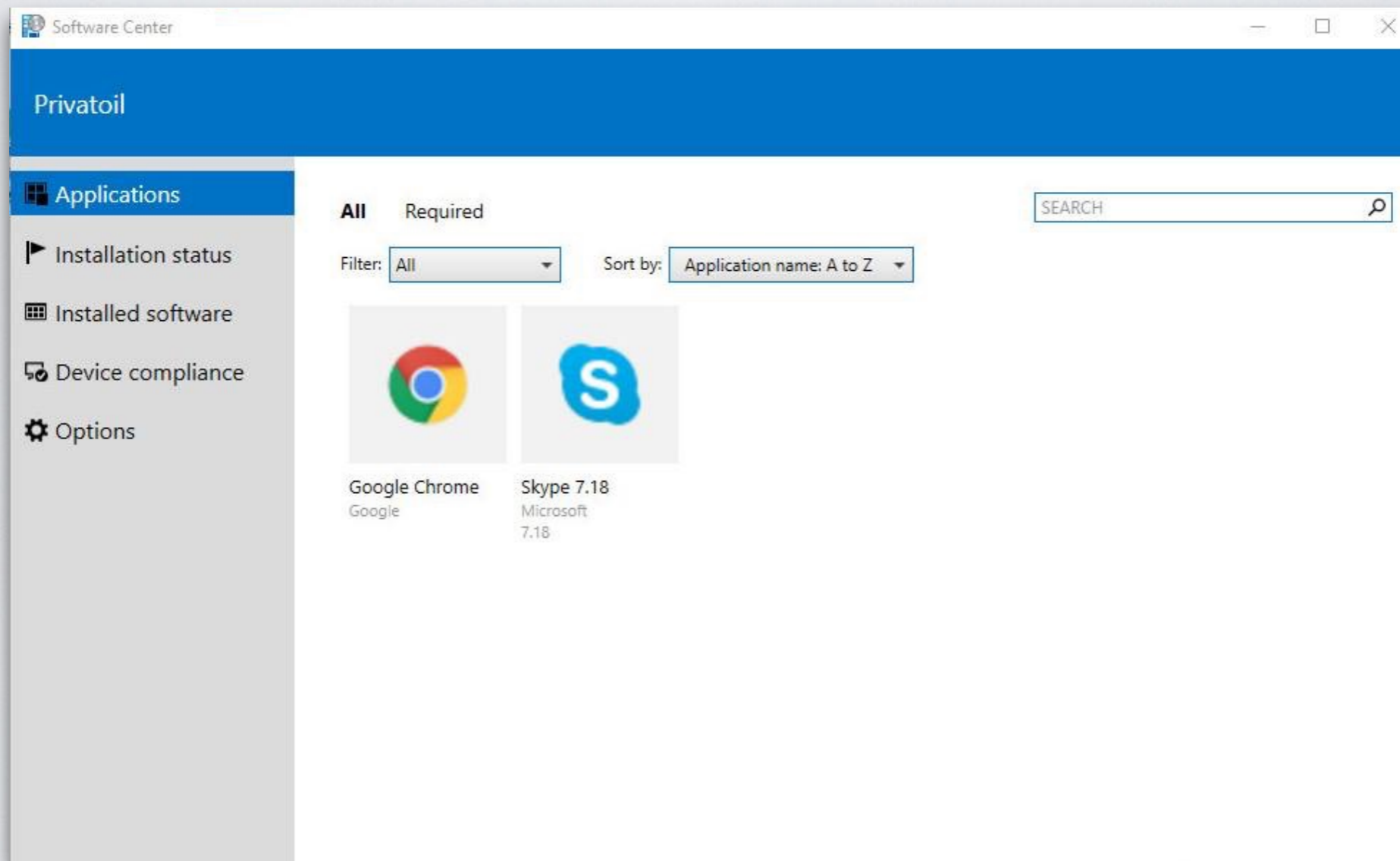

NYTT I SCCM 2016

MICROSOFT SCCM 2016

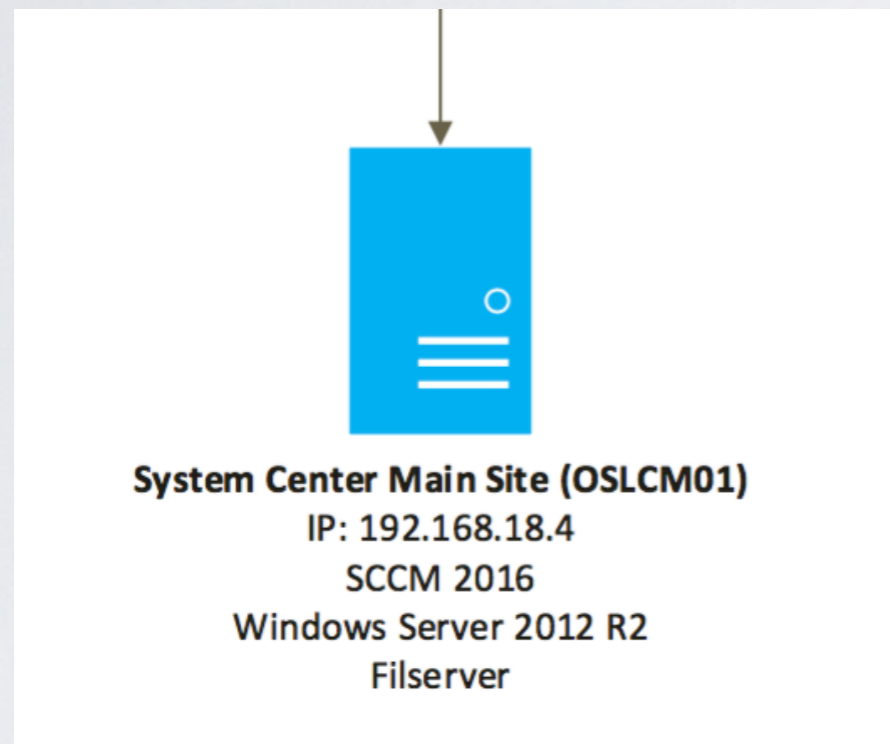

- System Center Configuration Manager 2012 R2 SP2
- Nytt software center
- Tett integrasjon mot Windows 10
- Hybrid-connector
- Preferred-management points

VÅR LØSNING

MICROSOFT SCCM 2016

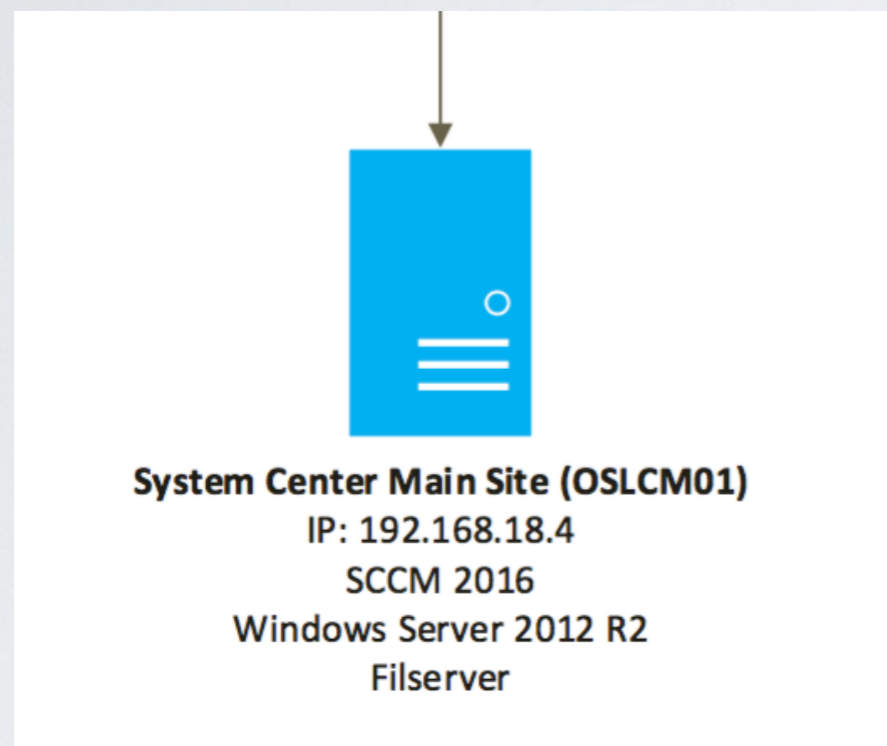

- Fjernadministrasjon
- Sentraldistribusjon
- Sentralstyring

VÅR LØSNING - SCCM 2016

FJERNADMINISTRASJON

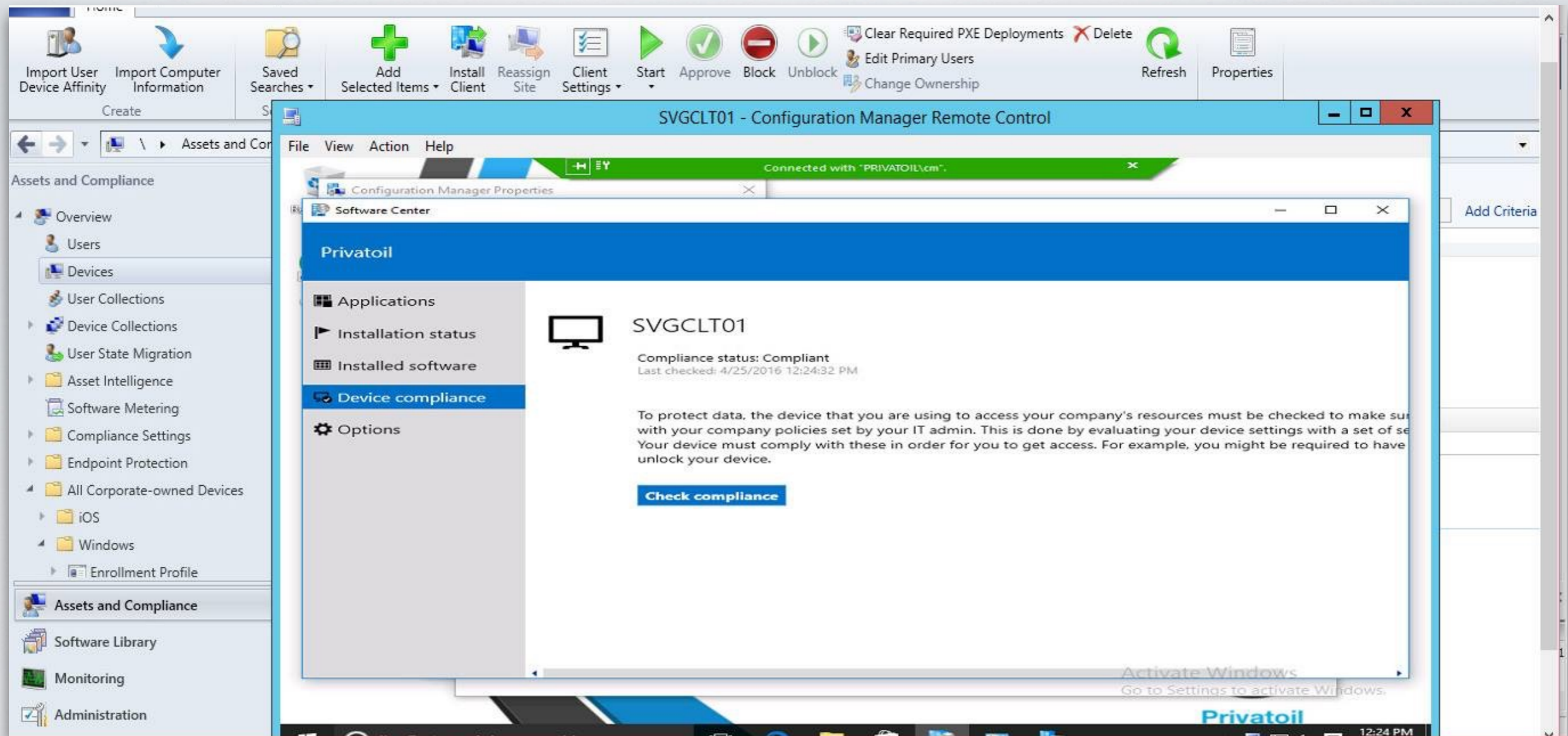

VÅR LØSNING - SCCM 2016

SENTRALDISTRIBUSJON

Content Status 17 items

Search X Search Add Criteria

Icon	Software	Type	Targeted	Size (MB)	Compliance %	Date Created	Package ID	Source
	Adobe Reader English	Application	3	130,00	100,0	24.02.2016 11:40	OSL00020	1
	Adobe Reader Norsk	Application	3	130,00	100,0	24.02.2016 11:30	OSL0001F	1
	Boot image (x64)	Boot Image	2	255,87	100,0	25.02.2016 12:09	OSL00022	5
	Boot image (x86)	Boot Image	2	199,71	100,0	25.02.2016 11:10	OSL00023	3
	Configuration Manager Client Package	Package	2	214,58	100,0	15.02.2016 12:17	OSL00003	1
	Configuration Manager Client Upgrade Package	Package	2	1,71	100,0	15.02.2016 12:17	OSL00004	1
	Endpoint-Klienter	Software Update Package	2	2 517,79	100,0	25.04.2016 00:17	OSL0002B	107
	Endpoint-Servere	Software Update Package	2	2 490,34	100,0	25.04.2016 00:11	OSL0002C	106
	GeoGebra 5 for Privatoil	Application	3	63,66	100,0	29.02.2016 18:36	OSL0002D	3
	Google Chrome	Application	3	43,97	100,0	24.02.2016 11:07	OSL0001D	1
	Microsoft Corporation User State Migration Tool f...	Package	0	102,79		15.02.2016 12:14	OSL00001	1

Adobe Reader English

General

Software: Adobe Reader English
 Type: Application
 Date Created: 24.02.2016 11:40
 Package ID: OSL00020

Completion Statistics



3 Targeted (Last Update: 14.04.2016 11:16) [View Status](#)

■ Success: 3
■ In Progress: 0
■ Failed: 0
■ Unknown: 0

VÅR LØSNING - SCCM 2016

SENTRALSTYRING

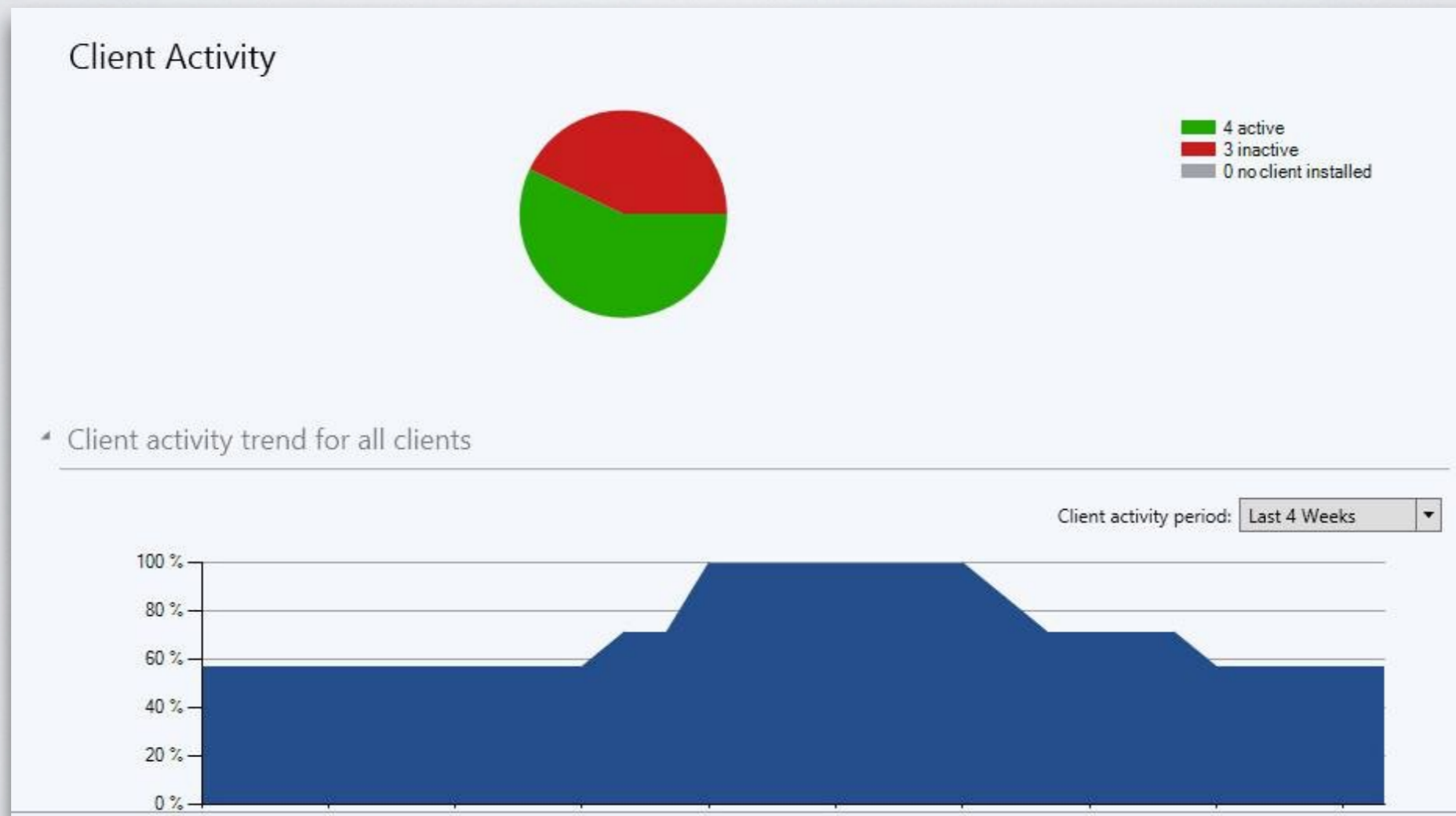

VÅR LØSNING - SCCM 2016

DEMO - OPERATIVSYSTEM DISTRUBUSJON

Import User Device Affinity
 Import Computer Information
 Saved Searches
 Add Selected Items
 Install Client
 Reassign Site
 Client Settings
 Start
 Approve
 Block
 Unblock
 Clear Required PXE Deployment
 Edit Primary Users
 Change Ownership

Create Search Device

Assets and Compliance > Overview > Devices

Assets and Compliance

- Overview
- Users
- Devices**
- User Collections
- Device Collections
- User State Migration
- Asset Intelligence
- Software Metering
- Compliance Settings
- Endpoint Protection
- All Corporate-owned Devices
 - iOS
 - Windows
 - Enrollment Profile

Assets and Compliance

Software Library

Devices 11 items

Search

Icon	Name	Client	Site Code	Client Activity
	OSLCLT01	Yes	OSL	Inactive
	OSLCLT02	Yes	OSL	Inactive
	OSLCLT03	Yes	OSL	Inactive
	OSLCM01	No		
	OSLDC01	Yes	OSL	Active
	OSLSQL01	Yes	OSL	Active
	SVGCLT01	Yes	OSL	Active
	SVGCLT02	Yes	OSL	Active
	SVGCM01	No		
	x64 Unknown Computer...	No	OSL	
	x86 Unknown Computer...	No	OSL	

SVGCLT01

Icon	Rule Name	Evaluation Time	Result	Result Code	Detail
	All Evaluat...	25.04.2016 12:32	Evaluat...		

Home Folder

Create Task Sequence Create Task Sequence Media Import Task Sequence Saved Searches Search

Software Library Overview

Software Library

- Windows Sideload Keys
- Application Management Policies
- Software Updates
 - All Software Updates
 - Software Update Groups
 - Deployment Packages
 - Automatic Deployment Rules
- Operating Systems
 - Drivers
 - Driver Packages
 - Operating System Images
 - Operating System Upgrade Packages
 - Boot Images
 - Task Sequences
- Assets and Compliance
- Software Library
- Monitoring
- Administration

Ready

Installer Windows 10 for Oslo Task Sequence Editor

Add Remove

Properties Options

Type: Group

Name: Capture Files and Settings

Description: Actions to capture files and settings in the original operating system

No settings are required for this action.

OK Cancel Apply

- Capture Files and Settings**
 - Disable BitLocker
- Install Operating System**
 - Restart in Windows PE
 - Partition Disk 0 - BIOS
 - Partition Disk 0 - UEFI
 - Pre-provision BitLocker
 - Apply Operating System
 - Apply Windows Settings
 - Apply Network Settings
 - Apply Device Drivers
- Setup Operating System**
 - Setup Windows and Configuration
 - Enable BitLocker
 - Install Updates
 - Install Applications

Summary References Deployments

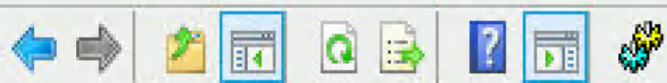

Option Name	Vendor	Value	Policy Name
003 Router	Standard	192.168.18.1	None
006 DNS Servers	Standard	192.168.18.2	None
015 DNS Domain Name	Standard	brukere.privatoil.no	None
066 Boot Server Host Name	Standard	192.168.18.4	None
067 Bootfile Name	Standard	SMSBoot\x64\wdsnbp.com	None

PhoenixBIOS 4.0 Release 6.0
Copyright 1985-2001 Phoenix Technologies Ltd.
All Rights Reserved
Copyright 2000-2013 VMware, Inc.
VMware BIOS build 397b

vmware®

639K System RAM Passed
7167M Extended RAM Passed
ATAPI CD-ROM: VMware Virtual IDE CDROM Drive
Mouse initialized

Press F2 to enter SETUP, F12 for Network Boot, ESC for Boot Menu

0 06

Loading files...

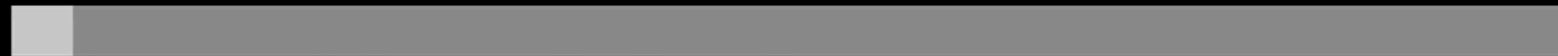

IP: 192.168.118.4, File: \SMSBoot\boot.sdi

Loading files...



IP: 192.168.118.4, File: \SMSImages\OSL00022\winpe.OSL00022.wim

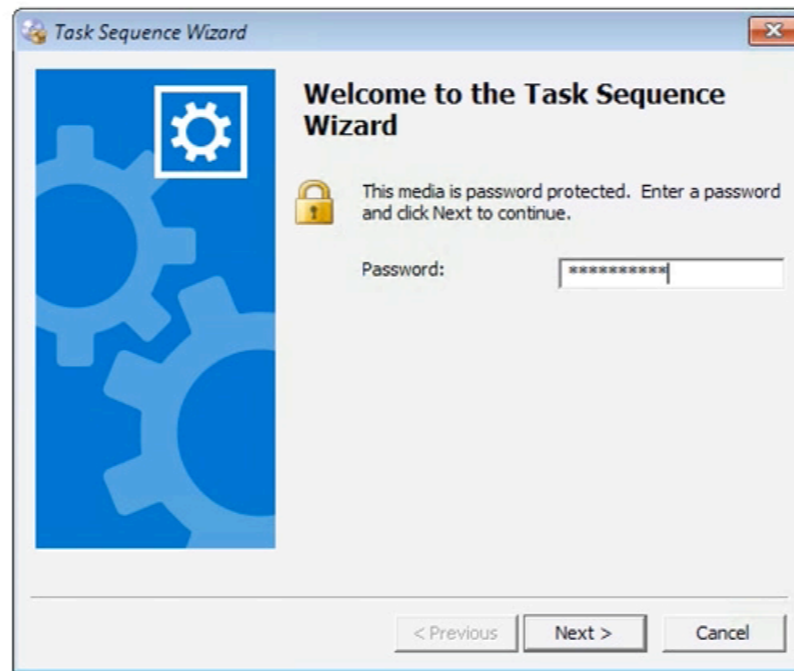

Home Folder

Create Task Sequence Create Task Sequence Media Import Task Sequence Saved Searches Search

Software Library Overview

Software Library

- Windows Sideload Keys
- Application Management Policies
- Software Updates
 - All Software Updates
 - Software Update Groups
 - Deployment Packages
 - Automatic Deployment Rules
- Operating Systems
 - Drivers
 - Driver Packages
 - Operating System Images
 - Operating System Upgrade Packages
 - Boot Images
 - Task Sequences
- Assets and Compliance
- Software Library
- Monitoring
- Administration

Ready

Installer Windows 10 for Oslo Task Sequence Editor

Add Remove

Properties Options

Type: Group

Name: Capture Files and Settings

Description: Actions to capture files and settings in the original operating system

No settings are required for this action.

OK Cancel Apply

- Capture Files and Settings**
 - Disable BitLocker
- Install Operating System**
 - Restart in Windows PE
 - Partition Disk 0 - BIOS
 - Partition Disk 0 - UEFI
 - Pre-provision BitLocker
 - Apply Operating System
 - Apply Windows Settings
 - Apply Network Settings
 - Apply Device Drivers
- Setup Operating System**
 - Setup Windows and Configuration
 - Enable BitLocker
 - Install Updates
 - Install Applications

Summary References Deployments

Installation Progress

 **Privatoil**
Running: Installer Windows 10 for Stavanger

Running action: Setup Windows and Configuration Manager



Installing Configuration Manager Client Agent ...

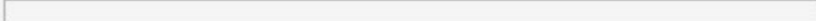

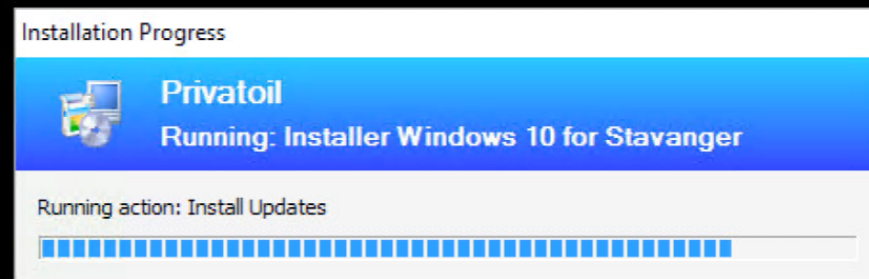

Installation Progress

 **Privatool**
Running: Installer Windows 10 for Stavanger

Running action: Install Applications

Installing 1 of 1 programs - 'Google Chrome'



[Control Panel Home](#)[Device Manager](#)[Remote settings](#)[System protection](#)[Advanced system settings](#)

View basic information about your computer

Windows edition

Windows 10 Enterprise

© 2016 Microsoft Corporation. All rights reserved.



Windows 10

System

Processor:	Intel(R) Xeon(R) CPU E5-2640 v2 @ 2.00GHz 2.00 GHz (2 processors)
Installed memory (RAM):	6.00 GB
System type:	64-bit Operating System, x64-based processor
Pen and Touch:	No Pen or Touch Input is available for this Display

Computer name, domain, and workgroup settings

Computer name:	SVGCLT01	Change settings
Full computer name:	SVGCLT01.brukere.privatoil.no	
Computer description:		
Domain:	brukere.privatoil.no	

Windows activation

Windows is not activated. [Read the Microsoft Software License Terms](#)

Product ID: 00329-00000-00003-AA515

[Activate Windows](#)[See also](#)[Security and Maintenance](#)

VÅR LØSNING - SCCM 2016

DEMO - POWERSHELL

Privatoil

- Applications**
- Installation status
- Installed software
- Device compliance
- Options

All Required

SEARCH 🔍

Filter: All ▾

Sort by: Application name: A to Z ▾

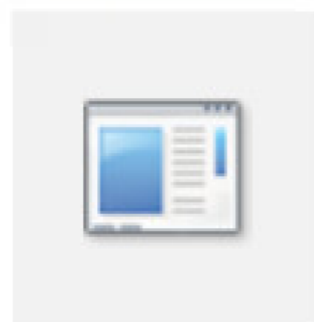

GeoGebra

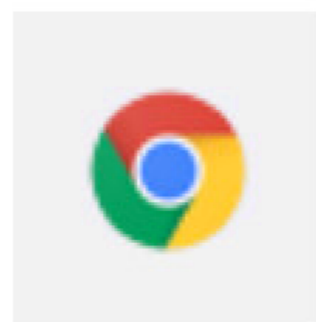

Google Chrome
Google

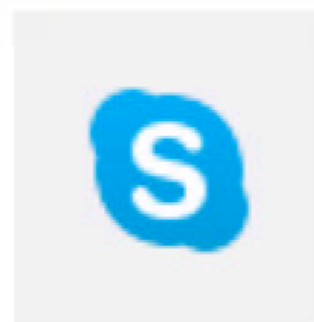

Skype 7.18
Microsoft
7.18

VÅR LØSNING

MICROSOFT SCCM 2016

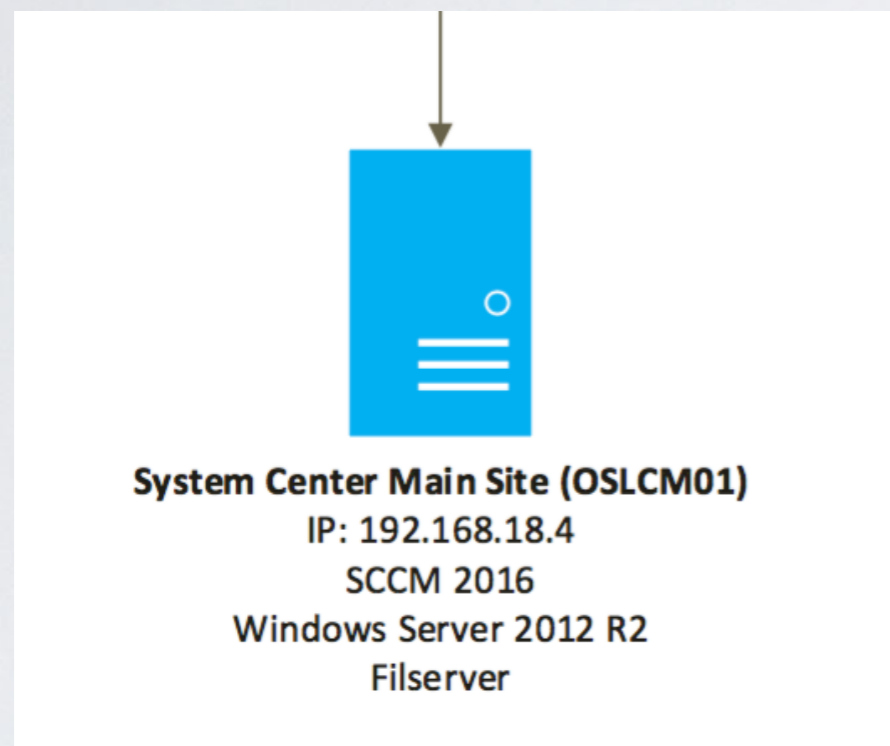

- Fjernadministrasjon
- Sentraldistribusjon
- Sentralstyring

VÅR LØSNING

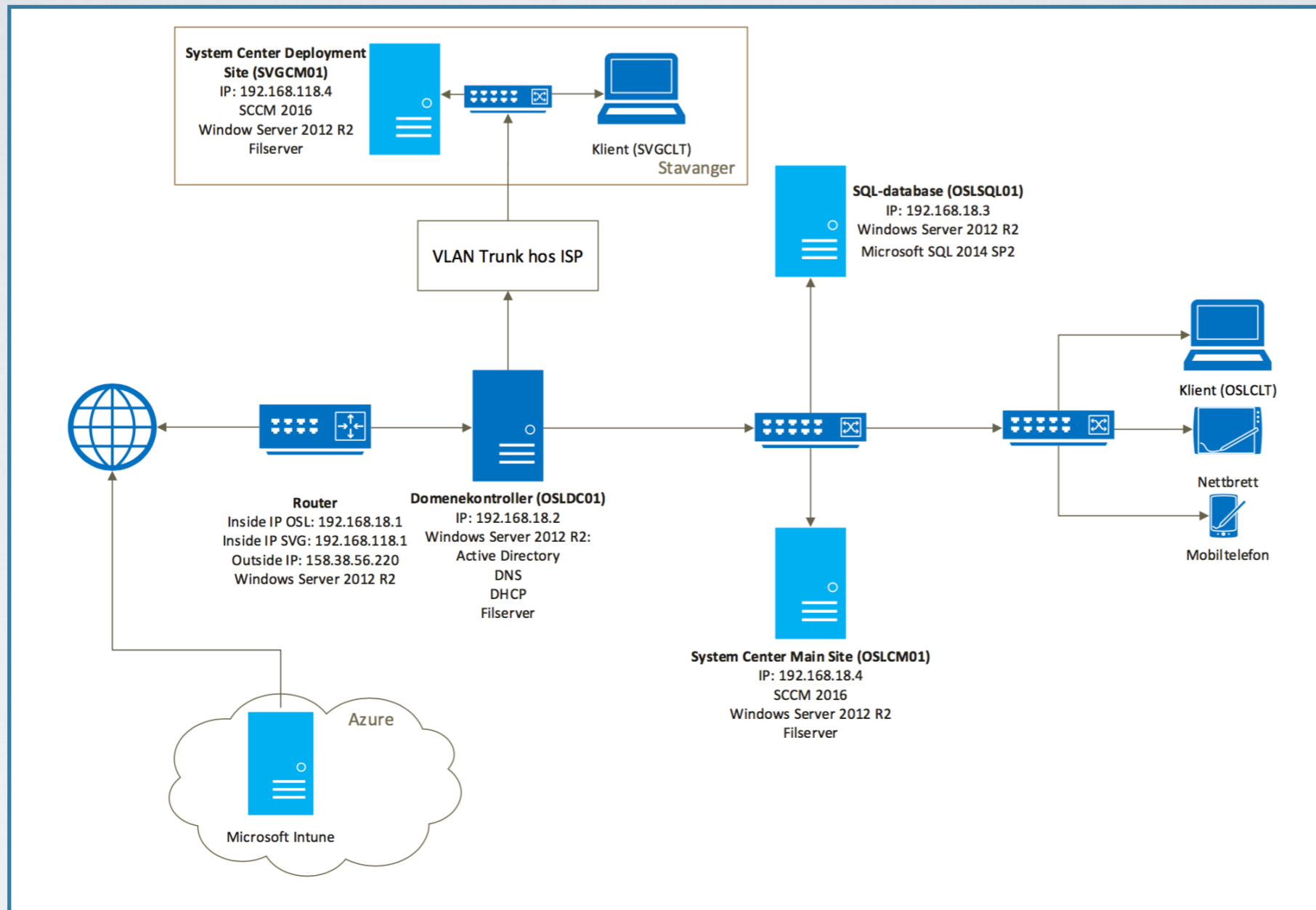

GENERELT OM MICROSOFT INTUNE

- Selvstendig løsning
 - Egen Webportal
 - Kostnadseffektivt for små bedrifter
- Hybrid
 - SCCM internt, Intune eksternt
- Mobile Device Management

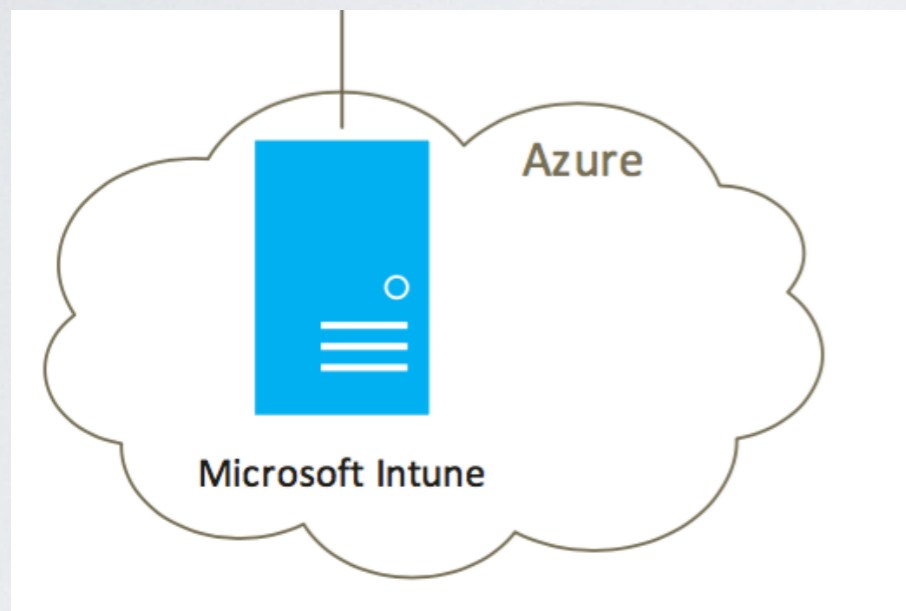

VÅR LØSNING

MICROSOFT INTUNE

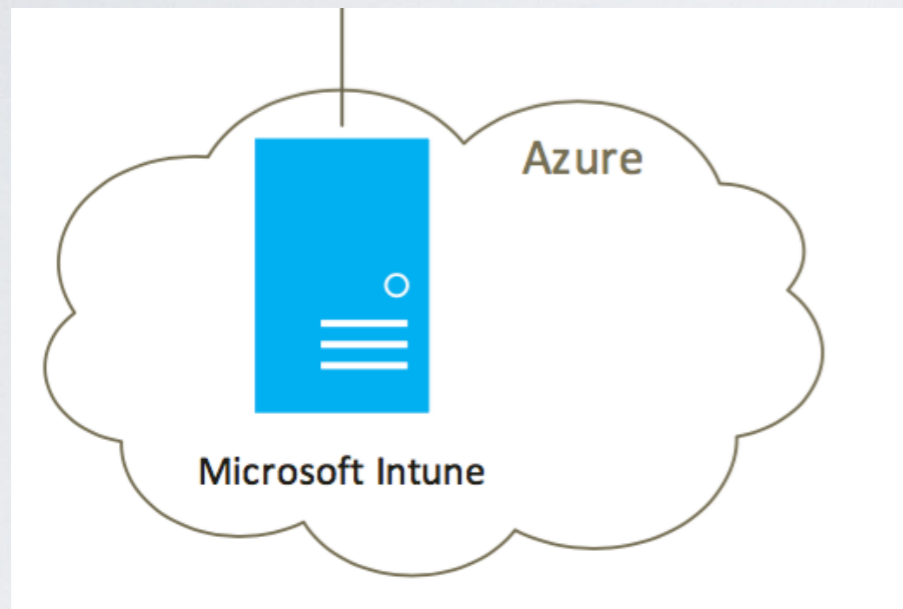

- Hybrid-løsning
 - AD-connector - SSO
 - Boundaries og PMP
- Mobile Device Management
 - Compliance - og configuration policy
 - Fjernsletting

VÅR LØSNING

MICROSOFT INTUNE

Security

Password

- Require a password to unlock mobile devices (iOS 7.1 and later) : ⓘ
Yes
- Required password type (iOS 7.1 and later) : ⓘ
Alphanumeric
- Number of complex characters required in password (iOS 7.1 and later) : ⓘ
0
- Minimum password length (iOS 7.1 and later) : ⓘ
4
- Allow simple passwords (iOS 7.1 and later) : ⓘ
No
- Number of repeated sign-in failures to allow before the device is wiped (iOS 7.1 and later) : ⓘ
10
- Minutes of inactivity before password is required (iOS 7.1 and later) : ⓘ
1 minute
- Password expiration (days) (iOS 7.1 and later) : ⓘ
80
- Remember password history (iOS 7.1 and later) : ⓘ
Yes
- Prevent reuse of previous passwords (iOS 7.1 and later) : ⓘ
5

VÅR LØSNING

MICROSOFT INTUNE

Allow control center in lock screen (iOS 7.1 and later) : ⓘ

No ▼

Allow notification view in lock screen (iOS 7.1 and later) : ⓘ

No ▼

Allow camera (iOS 7.1 and later) : ⓘ

No ▼

UTEN POLICY

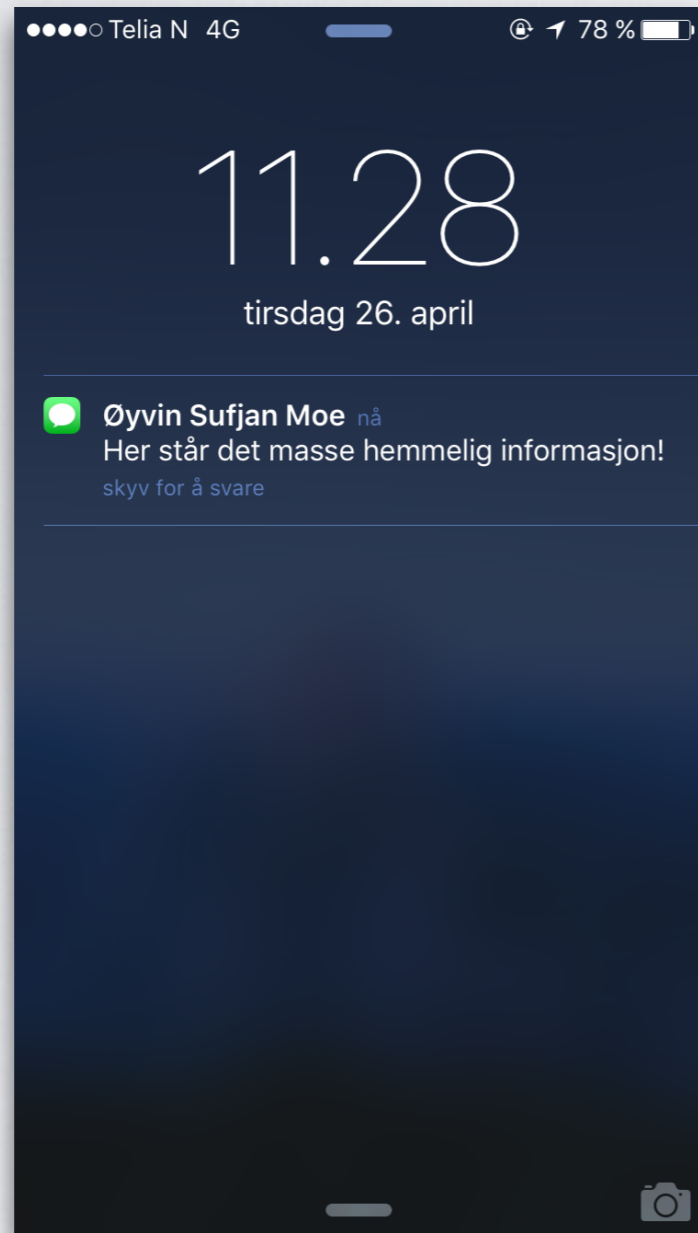

MED POLICY



LIVE DEMO
FJERNSLETNING

VÅR LØSNING

MICROSOFT INTUNE

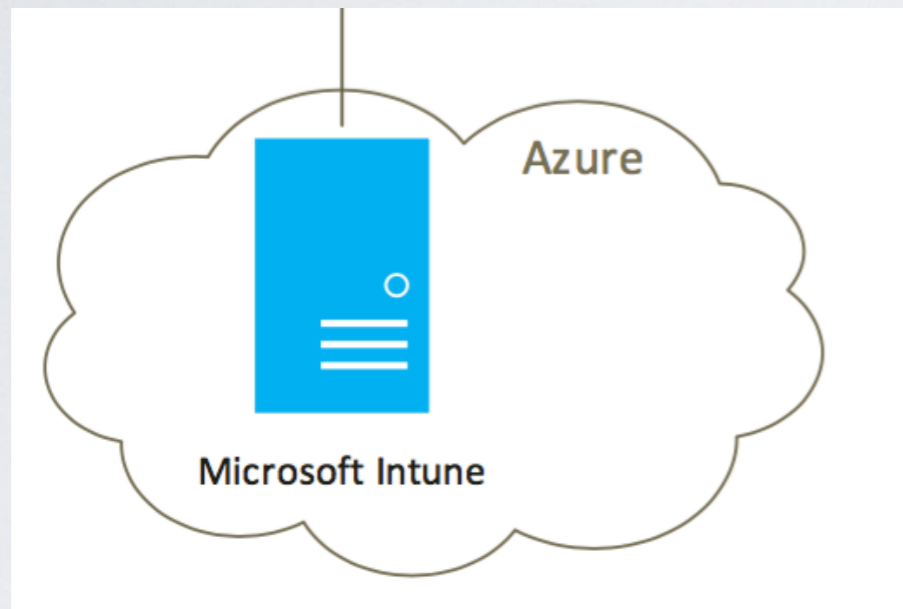

- Hybrid-løsning
 - AD-connector - SSO
 - Boundaries og PMP
- Mobile Device Management
 - Compliance - og configuration policy
 - Fjernsletting

VÅR LØSNING

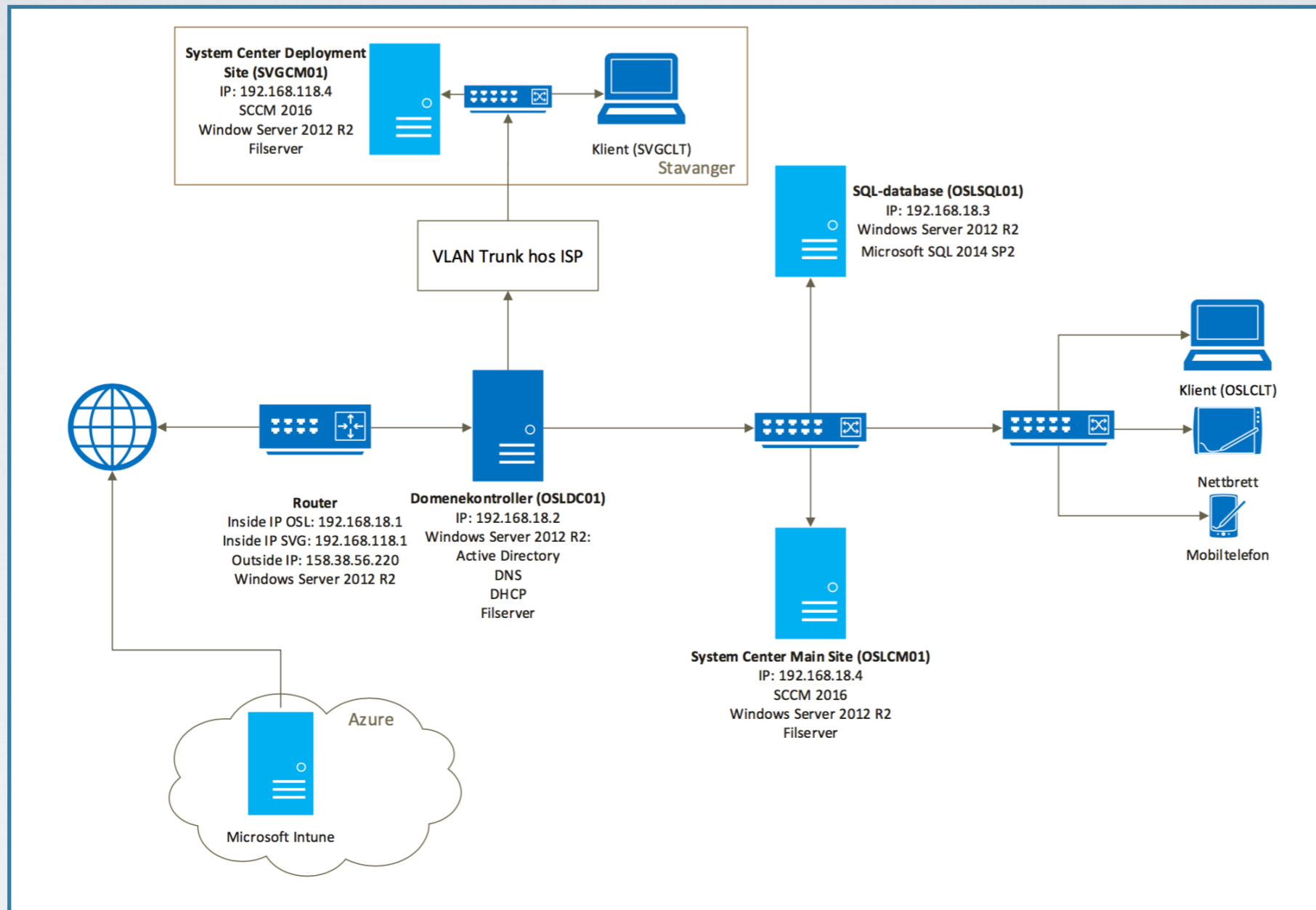

PROSESSEN

- Tidlig start
- Jevn arbeidsprosess
- Godt samarbeid

VIDERE ARBEID

- Skolens brannmurer
- Oppdateringer - Windows as a service
- Vurdere SCCM i sky mot Intune
- Kontinuerlig vedlikehold

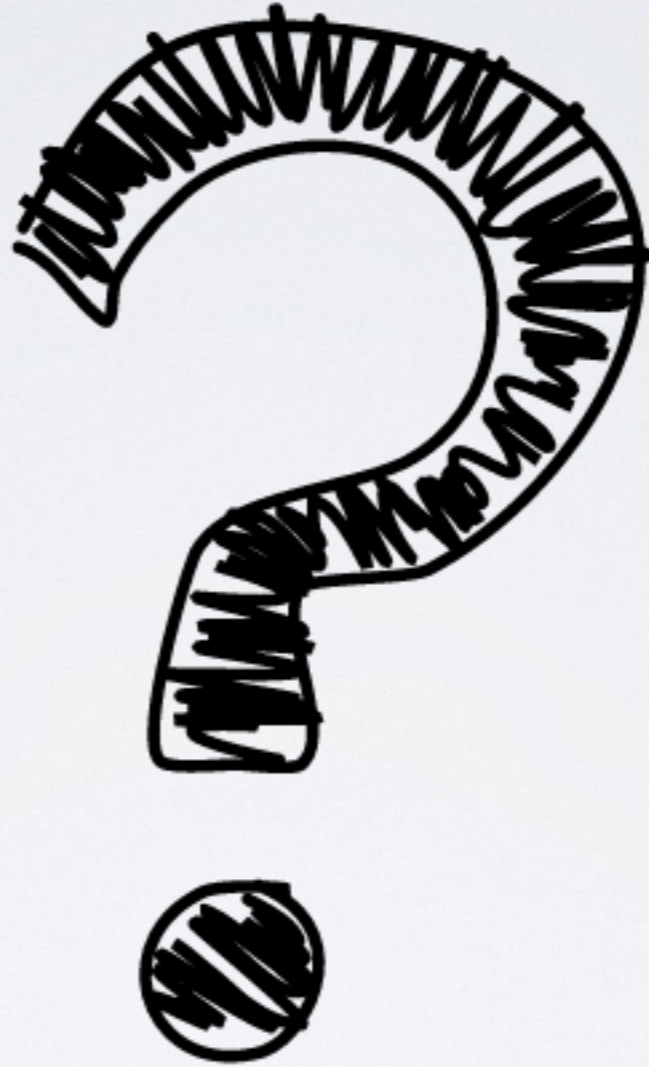

TAKK FOR OSS